

FLOAT CASEGOODS PRICE LIST

DECCA | CONTRACT

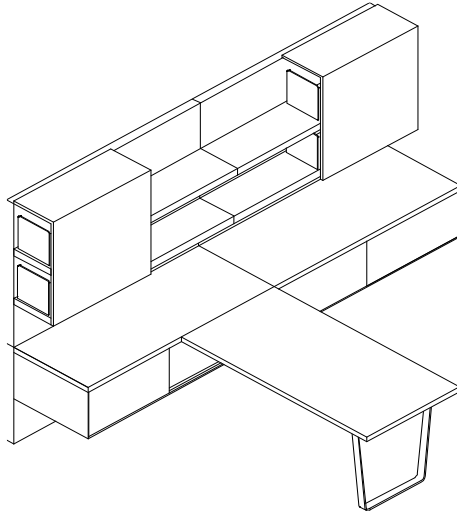

CONFIGURATION A

MODEL	STANDARD VENEER STANDARD METAL	STANDARD VENEER GI PREMIUM METAL	STANDARD VENEER GII PREMIUM METAL
FT-WM72228 WALL MOUNT PANEL	US\$3,760	US\$3,760	US\$3,760
FT-WM72258 WALL MOUNT PANEL	US\$3,033	US\$3,033	US\$3,033
FT-W721331D PANEL MOUNT OVERHEAD	US\$9,936	US\$9,936	US\$9,936
FT-LED EXTRA LED LIGHTING	US\$1,118	US\$1,118	US\$1,118
FT-BKE BOOKEND	US\$3,465	US\$4,158	US\$4,504
FT-BT7224 TOP SURFACE	US\$2,693	US\$3,231	US\$2,693
FT-WP3624F PANEL MOUNT PEDESTAL	US\$8,574	US\$8,574	US\$8,574
FT-WP3624B PANEL MOUNT PEDESTAL	US\$4,360	US\$4,360	US\$4,360
FT-WP3624S PANEL MOUNT PEDESTAL	US\$2,518	US\$2,518	US\$2,518
FT-RT7236 RUNOFF	US\$4,120	US\$4,944	US\$5,356
TOTAL	US\$43,576	US\$45,632	US\$45,852

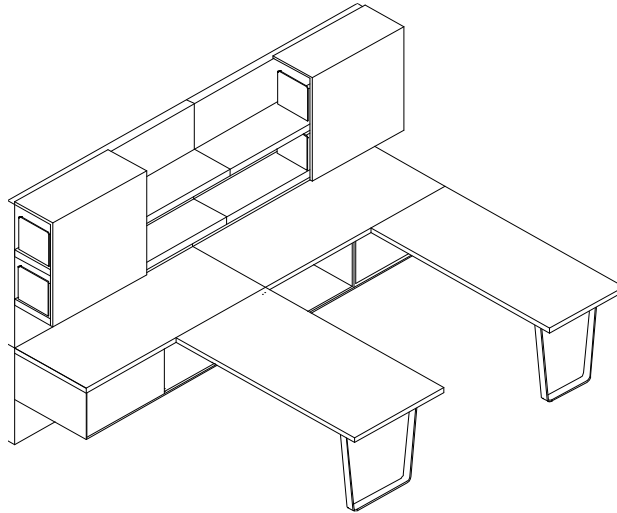

CONFIGURATION B

MODEL	STANDARD VENEER	STANDARD VENEER	STANDARD VENEER
	STANDARD METAL	GI PREMIUM METAL	GII PREMIUM METAL
FT-WM72228 WALL MOUNT PANEL	US\$3,823	US\$3,823	US\$3,823
FT-WM72258 WALL MOUNT PANEL	US\$3,033	US\$3,033	US\$3,033
FT-W721331D PANEL MOUNT OVERHEAD	US\$9,936	US\$9,936	US\$9,936
FT-LED EXTRA LED LIGHTING	US\$1,118	US\$1,118	US\$1,118
FT-BKE BOOKEND	US\$3,465	US\$4,158	US\$4,504
FT-BT7224 TOP SURFACE	US\$2,693	US\$2,693	US\$2,693
FT-WP3624S PANEL MOUNT PEDESTAL	US\$2,518	US\$2,518	US\$2,518
FT-WP3624P PANEL MOUNT PEDESTAL	US\$4,287	US\$4,287	US\$4,287
FT-WP3624BC PANEL MOUNT PEDESTAL	US\$2,669	US\$2,669	US\$2,669
FT-WP3624F PANEL MOUNT PEDESTAL	US\$4,287	US\$4,287	US\$4,287
FT-RT6030 RUNOFF	US\$3,406	US\$4,087	US\$4,427
FT-RT7224 RUNOFF	US\$3,916	US\$4,699	US\$5,091
TOTAL	US\$45,151	US\$47,308	US\$48,387

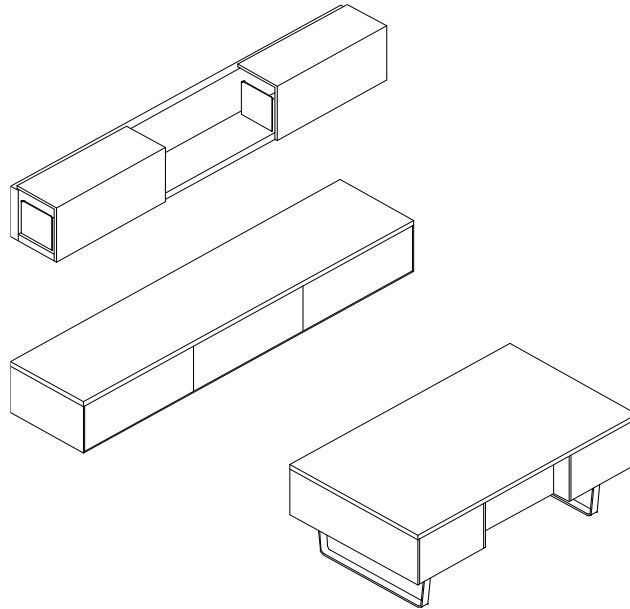

CONFIGURATION C

MODEL	STANDARD VENEER	STANDARD VENEER	STANDARD VENEER
	STANDARD METAL	GI PREMIUM METAL	GII PREMIUM METAL
FT-WM54216 WALL MOUNT PANEL	US\$1,787	US\$1,787	US\$1,787
FT-W541316 PANEL MOUNT OVERHEAD	US\$6,601	US\$6,601	US\$6,601
FT-BKE BOOKEND	US\$1,732	US\$2,079	US\$2,252
FT-BT10824 TOP SURFACE	US\$3,530	US\$3,530	US\$3,530
FT-WP3624F PANEL MOUNT PEDESTAL	US\$12,861	US\$12,861	US\$12,861
FT-D7236LBRF DOUBLE PED DESK	US\$7,112	US\$8,534	US\$9,246
TOTAL	US\$33,624	US\$35,393	US\$36,278

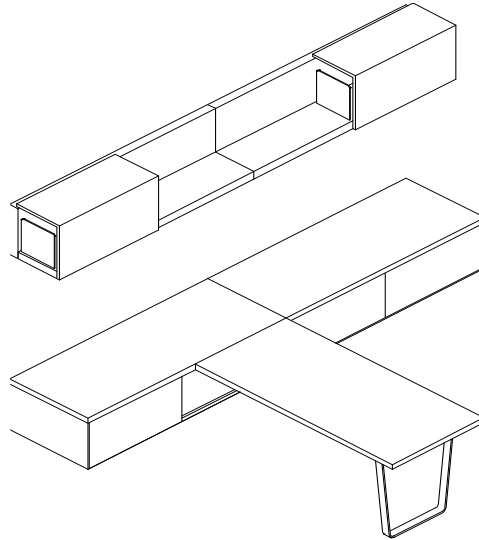

CONFIGURATION D

MODEL	STANDARD VENEER	STANDARD VENEER	STANDARD VENEER
	STANDARD METAL	GI PREMIUM METAL	GII PREMIUM METAL
FT-WM60216 WALL MOUNT PANEL	US\$2,118	US\$2,118	US\$2,118
FT-W601316D PANEL MOUNT OVERHEAD	US\$7,984	US\$7,984	US\$7,984
FT-BKE BOOKEND	US\$1,732	US\$2,079	US\$2,252
FT-BT6024 TOP SURFACE	US\$2,362	US\$2,362	US\$2,362
FT-WP3024B PANEL MOUNT PEDESTAL	US\$3,861	US\$3,861	US\$3,861
FT-WP3024F PANEL MOUNT PEDESTAL	US\$7,580	US\$7,580	US\$7,580
FT-WP3024S PANEL MOUNT PEDESTAL	US\$2,406	US\$2,406	US\$2,406
FT-RT6630 RUNOFF	US\$3,711	US\$4,453	US\$4,824
TOTAL	US\$31,755	US\$32,844	US\$33,388

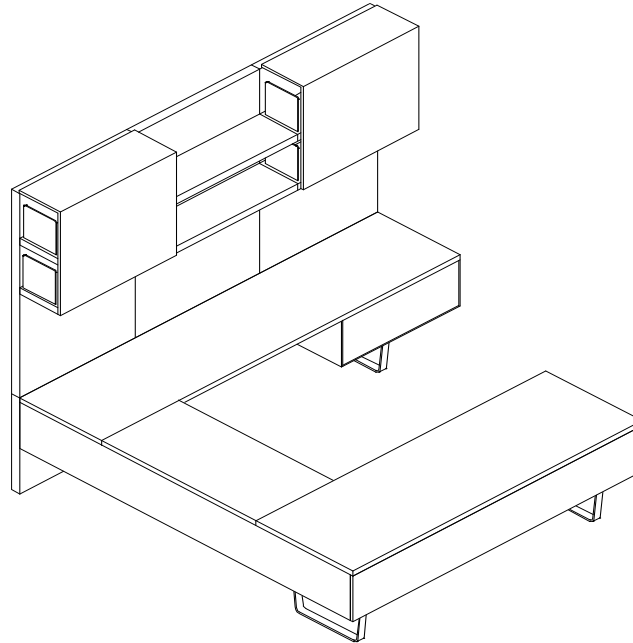

CONFIGURATION E

MODEL	STANDARD VENEER	STANDARD VENEER	STANDARD VENEER
	STANDARD METAL	GI PREMIUM METAL	GII PREMIUM METAL
FT-WM54228 WALL MOUNT PANEL	US\$3,222	US\$3,222	US\$3,222
FT-WM54258 WALL MOUNT PANEL	US\$2,036	US\$2,036	US\$2,036
FT-W541331D PANEL MOUNT OVERHEAD	US\$9,015	US\$9,015	US\$9,015
FT-BKE BOOKEND	US\$3,465	US\$4,158	US\$4,504
FT-BT10824 TOP SURFACE	US\$3,530	US\$3,530	US\$3,530
FT-WP3624FANEL MOUNT PEDESTAL	US\$4,287	US\$4,287	US\$4,287
FT-LEG LEG	US\$1,804	US\$2,165	US\$2,345
FT-B4224M BRIDGE	US\$2,400	US\$2,400	US\$2,400
FT-S6630LBRO SINGLE PED DESK	US\$5,709	US\$6,851	US\$7,422
TOTAL	US\$35,468	US\$37,663	US\$38,761

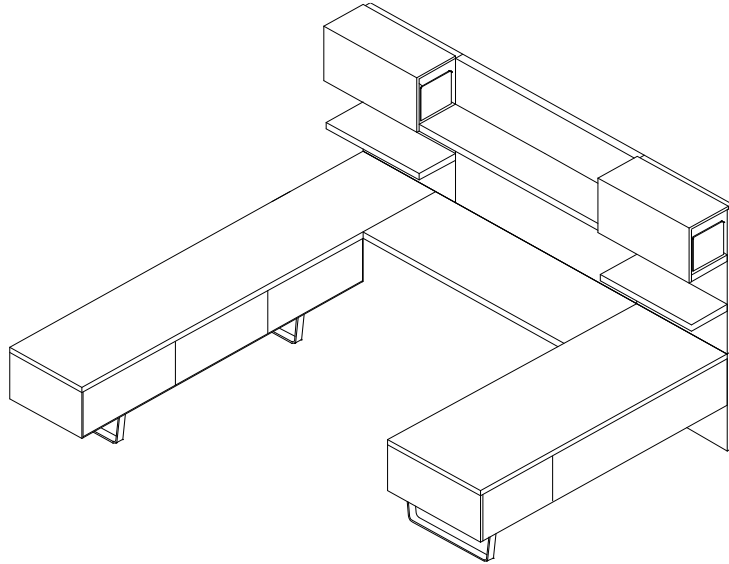

CONFIGURATION F

MODEL	STANDARD VENEER	STANDARD VENEER	STANDARD VENEER
	STANDARD METAL	GI PREMIUM METAL	GII PREMIUM METAL
FT-WM54228 WALL MOUNT PANEL	US\$3,222	US\$3,222	US\$3,222
FT-WM54258 WALL MOUNT PANEL	US\$2,036	US\$2,036	US\$2,036
FT-W541316D PANEL MOUNT OVERHEAD	US\$7,677	US\$7,677	US\$7,677
FT-BKE BOOKEND	US\$1,732	US\$2,079	US\$2,252
FT-WS3612 PANEL MOUNT SHELF	US\$2,070	US\$2,070	US\$2,070
FT-BT78242 WORK SURFACE	US\$1,430	US\$1,430	US\$1,430
FT-S7230LORB SINGLE PED DESK	US\$5,933	US\$7,119	US\$7,713
FT-BT9624 WORK SURFACE	US\$1,679	US\$1,679	US\$1,679
FT-WP3024F PANEL MOUNT PEDESTAL	US\$7,580	US\$7,580	US\$7,580
FT-WP3624BC PANEL MOUNT PEDESTAL	US\$2,669	US\$2,669	US\$2,669
FT-LEG LEG	US\$3,608	US\$4,329	US\$4,690
TOTAL	US\$39,636	US\$41,891	US\$43,018

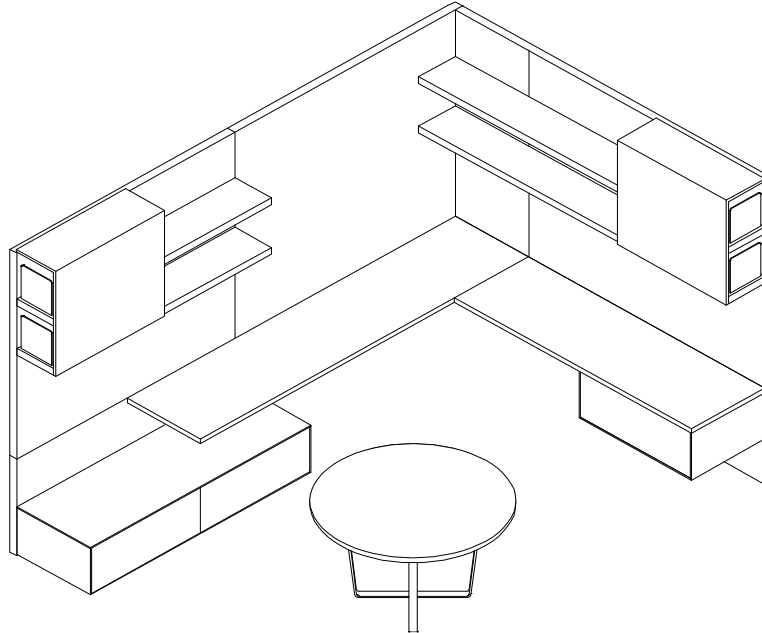

CONFIGURATION G

MODEL	STANDARD VENEER	STANDARD VENEER	STANDARD VENEER
	STANDARD METAL	GI PREMIUM METAL	GII PREMIUM METAL
FT-WM90228 WALL MOUNT PANEL	US\$1,851	US\$1,851	US\$1,851
FT-WM90258 WALL MOUNT PANEL	US\$1,897	US\$1,897	US\$1,897
FT-WM72228 WALL MOUNT PANEL	US\$1,520	US\$1,520	US\$1,520
FT-WM72258 WALL MOUNT PANEL	US\$1,517	US\$1,517	US\$1,517
FT-WM54228 WALL MOUNT PANEL	US\$1,251	US\$1,251	US\$1,251
FT-WM54258 WALL MOUNT PANEL	US\$1,018	US\$1,018	US\$1,018
FT-W721316D PANEL MOUNT OVERHEAD	US\$9,936	US\$9,936	US\$9,936
FT-BKE BOOKEND	US\$3,465	US\$4,158	US\$4,504
FT-CR7224LTLT LOW CREDENZA	US\$7,803	US\$7,803	US\$7,803
FT-BT9024 WORK SURFACE	US\$1,596	US\$1,596	US\$1,596
FT-WS1812 PANEL MOUNT SHELF	US\$1,532	US\$1,532	US\$1,532
FT-BT6624 WORK SURFACE	US\$1,264	US\$1,264	US\$1,264
FT-WP3624B PANEL MOUNT PEDESTAL	US\$4,360	US\$4,360	US\$4,360
DG-RD42	US\$3,384	US\$3,384	US\$3,384
FT-CM32	US\$3,880	US\$4,656	US\$5,044
TOTAL	US\$46,272	US\$47,741	US\$48,476

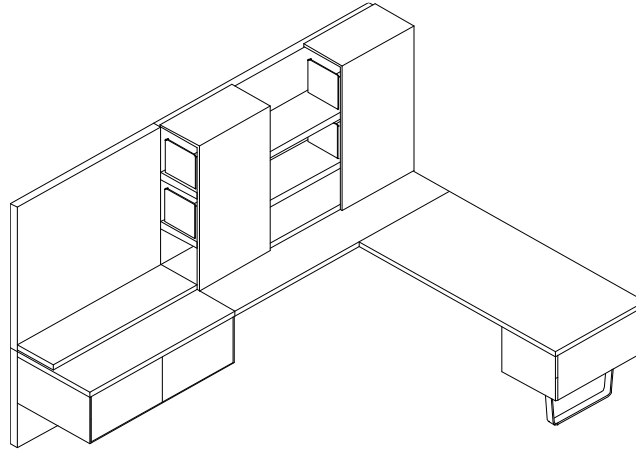

CONFIGURATION H

MODEL	STANDARD VENEER STANDARD METAL	STANDARD VENEER GI PREMIUM METAL	STANDARD VENEER GII PREMIUM METAL
FT-WM60228 WALL MOUNT PANEL	US\$1,701	US\$1,701	US\$1,701
FT-WM60258 WALL MOUNT PANEL	US\$1,143	US\$1,143	US\$1,143
FT-WS6012 PANEL MOUNT SHELF	US\$1,134	US\$1,134	US\$1,134
FT-BT6024 WORK SURFACE	US\$1,181	US\$1,181	US\$1,181
FT-WP3024F PANEL MOUNT PEDESTAL	US\$7,580	US\$7,580	US\$7,580
FT-WM72228 WALL MOUNT PANEL	US\$1,880	US\$1,880	US\$1,880
FT-WM72258 WALL MOUNT PANEL	US\$1,474	US\$1,474	US\$1,474
FT-WP361357 PANEL MOUNT OVERHEAD	US\$10,244	US\$10,244	US\$10,244
FT-BKE BOOKEND	US\$3,465	US\$4,158	US\$4,504
FT-BT7224 WORK SURFACE	US\$1,346	US\$1,346	US\$1,346
FT-RT7824MRB RUNOFF	US\$5,679	US\$6,815	US\$7,383
TOTAL	US\$36,826	US\$38,655	US\$39,569

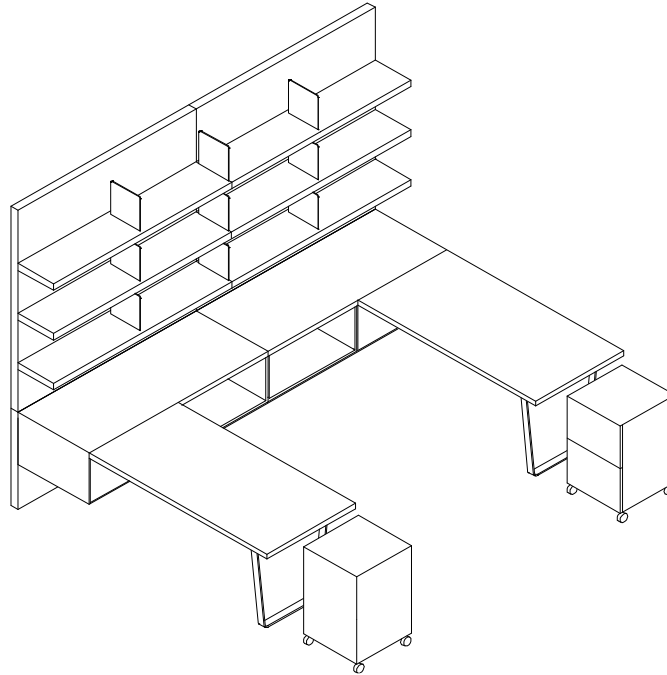

CONFIGURATION J

MODEL	STANDARD VENEER	STANDARD VENEER	STANDARD VENEER
	STANDARD METAL	GI PREMIUM METAL	GII PREMIUM METAL
FT-WM72228 WALL MOUNT PANEL	US\$3,039	US\$3,039	US\$3,039
FT-WM72258 WALL MOUNT PANEL	US\$3,033	US\$3,033	US\$3,033
FT-WS7212 PANEL MOUNT SHELF	US\$7,677	US\$7,677	US\$7,677
FT-BKE BOOKEND	US\$3,898	US\$4,678	US\$5,067
FT-BT7224 WORK SURFACE	US\$2,693	US\$2,693	US\$2,693
FT-WP3624OS PANEL MOUNT PEDESTAL	US\$5,194	US\$5,194	US\$5,194
FT-WP3624F PANEL MOUNT PEDESTAL	US\$8,574	US\$8,574	US\$8,574
FT-RT7230 RUNOFF	US\$8,650	US\$10,380	US\$11,245
FT-M1824BF MOBILE PEDESTAL	US\$6,419	US\$6,419	US\$6,419
TOTAL	US\$49,178	US\$51,688	US\$52,942

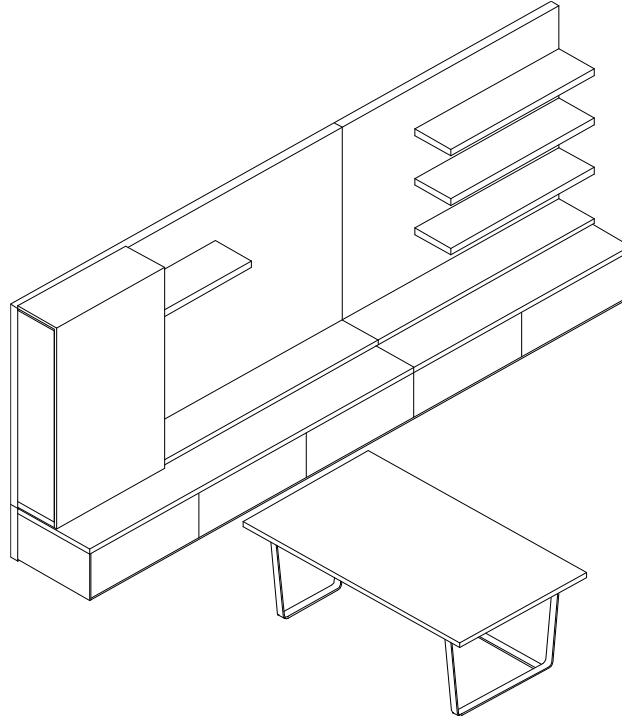

CONFIGURATION K

MODEL	STANDARD VENEER STANDARD METAL	STANDARD VENEER GI PREMIUM METAL	STANDARD VENEER GII PREMIUM METAL
FT-WM90228 WALL MOUNT PANEL	US\$1,787	US\$1,787	US\$1,787
FT-WM90258 WALL MOUNT PANEL	US\$1,897	US\$1,897	US\$1,897
FT-WM60228 WALL MOUNT PANEL	US\$1,340	US\$1,340	US\$1,340
FT-WM60258 WALL MOUNT PANEL	US\$1,184	US\$1,184	US\$1,184
FT-CR7224LTLT LOW CREDENZA	US\$7,803	US\$7,803	US\$7,803
FT-CR9024LTLT LOW CREDENZA	US\$11,385	US\$11,385	US\$11,385
FT-H301342C PANEL MOUNT HUTCH	US\$5,719	US\$5,719	US\$5,719
FT-WS4212D PANEL MOUNT SHELF	US\$3,105	US\$3,105	US\$3,105
FT-WS4812 PANEL MOUNT SHELF	US\$986	US\$986	US\$986
FT-WS9012PANEL MOUNT SHELF	US\$1,500	US\$1,500	US\$1,500
FT-WS6012 PANEL MOUNT SHELF	US\$1,134	US\$1,134	US\$1,134
FT-D7230 TABLE DESK	US\$5,416	US\$6,499	US\$7,041
TOTAL	US\$43,256	US\$44,339	US\$44,881

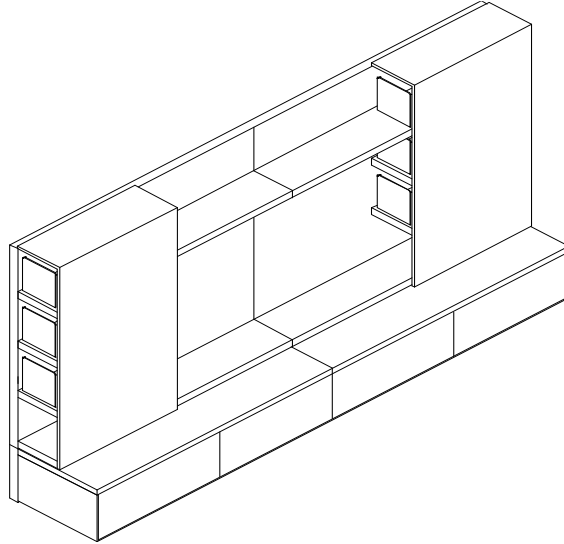

CONFIGURATION L

MODEL	STANDARD VENEER	STANDARD VENEER	STANDARD VENEER
	STANDARD METAL	GI PREMIUM METAL	GII PREMIUM METAL
FT-WM72228 WALL MOUNT PANEL	US\$3,039	US\$3,039	US\$3,039
FT-WM72258 WALL MOUNT PANEL	US\$2,751	US\$2,751	US\$2,751
FT-CR7224LTLT LOW CREDENZA	US\$14,156	US\$14,156	US\$14,156
FT-W721357 PANEL MOUNT OVERHEAD	US\$10,478	US\$10,478	US\$10,478
FT-BKE BOOKEND	US\$4,714	US\$5,657	US\$6,128
TOTAL	US\$35,139	US\$36,082	US\$36,553

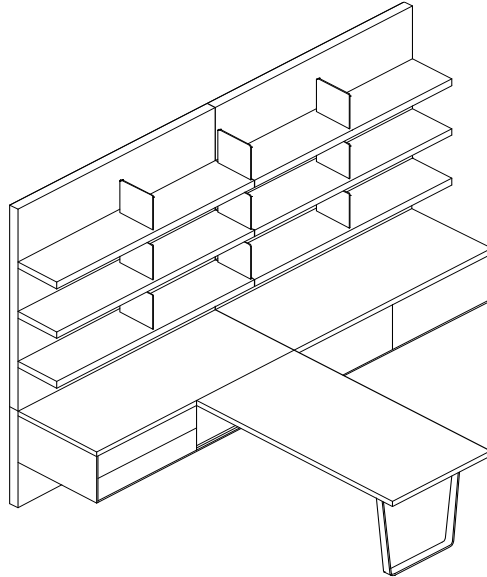

CONFIGURATION M

MODEL	STANDARD VENEER	STANDARD VENEER	STANDARD VENEER
	STANDARD METAL	GI PREMIUM METAL	GII PREMIUM METAL
FT-WM72228 WALL MOUNT PANEL	US\$3,760	US\$3,760	US\$3,760
FT-WM72258 WALL MOUNT PANEL	US\$3,033	US\$3,033	US\$3,033
FT-WS7212 PANEL MOUNT SHELF	US\$7,677	US\$7,677	US\$7,677
FT-BKE BOOKEND	US\$3,898	US\$4,678	US\$5,067
FT-BT7224 WORK SURFACE	US\$2,693	US\$2,693	US\$2,693
FT-WP3624F PANEL MOUNT PEDESTAL	US\$12,861	US\$12,861	US\$12,861
FT-WP3624S PANEL MOUNT PEDESTAL	US\$2,518	US\$2,518	US\$2,518
FT-RT7230 RUNOFF	US\$4,018	US\$4,822	US\$5,223
TOTAL	US\$40,458	US\$42,041	US\$42,833

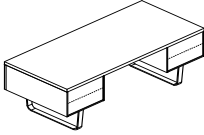
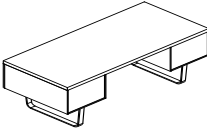
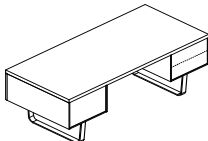
Description		Standard	Premium Metal G1 Upcharge	Premium Metal G2 Upcharge	Width	Depth	Height	Knee Space
Double Pedestal Desk Metal Support box / box drawer pedestals 	FT D6630LBRB	6686	1337	2006	66	30	28.75	30
	FT D6636LBRB	6871	1374	2061	66	36	28.75	30
	FT D7230LBRB	7056	1411	2117	72	30	28.75	36
	FT D7236LBRB	7241	1448	2172	72	36	28.75	36
	FT D7830LBRB	7426	1485	2228	78	30	28.75	36
	FT D7836LBRB	7611	1522	2283	78	36	28.75	36
Double Pedestal Desk Metal Support file drawer pedestals 	FT D6630LFRF	6533	1307	1960	66	30	28.75	30
	FT D6636LFRF	6676	1335	2003	66	36	28.75	30
	FT D7230LFRF	6820	1364	2046	72	30	28.75	36
	FT D7236LFRF	6963	1393	2089	72	36	28.75	36
	FT D7830LFRF	7107	1421	2132	78	30	28.75	36
	FT D7836LFRF	7251	1450	2175	78	36	28.75	36
Double Pedestal Desk Metal Support box / box pedestal and file drawer pedestal * 	FT D6630LFRB*	6609	1322	1983	66	30	28.75	30
	FT D6630LBRF							
	FT D6636LFRB	6777	1355	2033	66	36	28.75	30
	FT D6636LBRF							
	FT D7230LFRB	6944	1389	2083	72	30	28.75	36
	FT D7230LBRF							
	FT D7236LFRB	7112	1422	2134	72	36	28.75	36
	FT D7236LBRF							
	FT D7830LFRB	7279	1456	2184	78	30	28.75	36
	FT D7830LBRF							
FT D7836LFRB	7447	1489	2234	78	36	28.75	36	
FT D7836LBRF								

Notes

FINISHES

For a complete list of finishes please go to www.deccacontract.com

CODE DESCRIPTION

- B** box / box pedestal
- F** file pedestal
- L** Left pedestal position
- R** Right pedestal position

Dimensions are in inches and are approximate.

Contact Customer Service if dimensions are critical.

* Indicates model illustrated by line drawing.

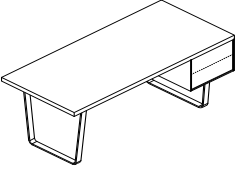
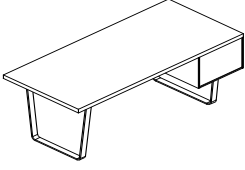
Description		Standard	Premium Metal G1 Upcharge	Premium Metal G2 Upcharge	Width	Depth	Height	Knee Space
Single Pedestal Desk Metal Support box / box pedestal * 	FT S6630LORB*	5709	1142	1713	66	30	28.75	41
	FT S6630LBR0							
	FT S6636LORB	5821	1164	1746	66	36	28.75	41
	FT S6636LBR0							
	FT S7230LORB	5933	1187	1780	72	30	28.75	45
	FT S7230LBR0							
	FT S7236LORB	6044	1209	1813	72	36	28.75	45
	FT S7236LBR0							
	FT S7830LORB	6156	1231	1847	78	30	28.75	51
	FT S7830LBR0							
FT S7836LORB	6268	1254	1880	78	36	28.75	51	
FT S7836LBR0								
Single Pedestal Desk Metal Support file drawer pedestal * 	FT S6630LORF*	5631	1126	1689	66	30	28.75	41
	FT S6630LFR0							
	FT S6636LORF	5719	1144	1716	66	36	28.75	41
	FT S6636LFR0							
	FT S7230LORF	5807	1161	1742	72	30	28.75	45
	FT S7230LFR0							
	FT S7236LORF	5894	1179	1768	72	36	28.75	45
	FT S7236LFR0							
	FT S7830LORF	5982	1196	1795	78	30	28.75	51
	FT S7830LFR0							
FT S7836LORF	6070	1214	1821	78	36	28.75	51	
FT S7836LFR0								

Notes

FINISHES

For a complete list of finishes please go to www.deccacontract.com



CODE DESCRIPTION

- B box / box pedestal
- F file pedestal
- L Left pedestal position
- R Right pedestal position

Dimensions are in inches and are approximate.

Contact Customer Service if dimensions are critical.

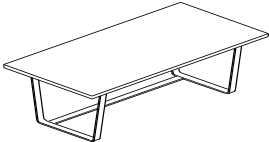
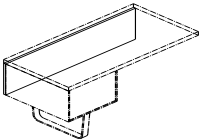
* Indicates model illustrated by line drawing.

Description		Standard	Premium Metal G1 Upcharge	Premium Metal G2 Upcharge	Width	Depth	Height	Knee Space
Table Desk Metal Support 	FT D6024	5081	1016	1524	60	24	28.75	42
	FT D6030	5148	1030	1544	60	30	28.75	42
	FT D6036	5215	1043	1564	60	36	28.75	42
	FT D6630	5282	1056	1584	66	30	28.75	48
	FT D6636	5349	1070	1605	66	36	28.75	48
	FT D7230	5416	1083	1625	72	30	28.75	54
	FT D7236	5483	1097	1645	72	36	28.75	54
	FT D7830	5550	1110	1665	78	30	28.75	60
	FT D7836	5617	1123	1685	78	36	28.75	60
H13" Modesty Panel Option Upcharge 	FT M	345						
Table Desk Intergrated with non-electric height adjustable mechanism 	FT DMH6630	8751	1750	2625	66	30	28.75	66
	FT DMH7230	8885	1777	2665	72	30	28.75	72
	FT DMH7830	9019	1804	2706	78	30	28.75	78
Table Desk Intergrated with electric height adjustable mechanism 	FT DEH6630	9861	1972	2958	66	30	28.75	66
	FT DEH7230	9992	1998	2998	72	30	28.75	72
	FT DEH7830	10129	2026	3039	78	30	28.75	78

Notes

FINISHES

For a complete list of finishes please go to www.deccacontract.com

Dimensions are in inches and are approximate.

Contact Customer Service if dimensions are critical.

* Indicates model illustrated by line drawing.

Description		Standard	Premium Metal G1 Upcharge	Premium Metal G2 Upcharge	Width	Depth	Height
Round Meeting Table Top	DG RD42	3384			42	42	1.5
	DG RD48	3491			48	48	1.5
	DG RD54	4880			54	54	1.5
Square Meeting Table Top	DG SQ42	3233			42	42	1.5
	DG SQ48	3649			48	48	1.5
	DG SQ54	4782			54	54	1.5
Cross Base	FT CM26	3812	762	1144	26	25	27.25
	FT CM32	3879	776	1164	32	32	27.25

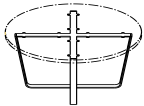

Notes

FINISHES

For a complete list of finishes please go to www.deccacontract.com

Dimensions are in inches and are approximate.

Contact Customer Service if dimensions are critical.

* Indicates model illustrated by line drawing.

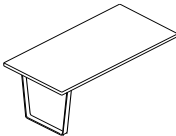
Description	Standard	Premium Metal G1 Upcharge	Premium Metal G2 Upcharge	Width	Depth	Height	Knee Space	
Desk Extension Metal Support 	FT RT4824	2895	579	868	48	24	28.75	39
	FT RT4830	2997	599	899	48	30	28.75	39
	FT RT5424	3099	620	930	54	24	28.75	45
	FT RT5430	3201	640	960	54	30	28.75	45
	FT RT6024	3303	661	991	60	24	28.75	51
	FT RT6030	3405	681	1022	60	30	28.75	51
	FT RT6036	3507	701	1052	60	36	28.75	51
	FT RT6624	3609	722	1083	66	24	28.75	57
	FT RT6630	3711	742	1113	66	30	28.75	57
	FT RT6636	3814	763	1144	66	36	28.75	57
	FT RT7224	3916	783	1175	72	24	28.75	63
	FT RT7230	4018	804	1205	72	30	28.75	63
	FT RT7236	4120	824	1236	72	36	28.75	63
	FT RT7824	4222	844	1267	78	24	28.75	69
	FT RT7830	4324	865	1297	78	30	28.75	69
	FT RT7836	4426	885	1328	78	36	28.75	69

Notes

FINISHES

For a complete list of finishes

please go to www.deccacontract.com

Dimensions are in inches and are approximate.

Contact Customer Service if dimensions are critical.

* Indicates model illustrated by line drawing.

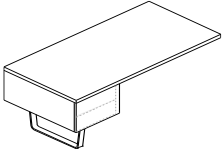
Description		Standard	Premium Metal G1 Upcharge	Premium Metal G2 Upcharge	Width	Depth	Height	Knee Space
Desk Extension Metal Support and 2 box drawers	FT RT4824LB *	4608	922	1382	48	24	28.75	30
	FT RT4824RB							
*	FT RT5424LB	4720	944	1416	54	24	28.75	36
	FT RT5424RB							
	FT RT5430LB	4832	966	1449	54	30	28.75	36
	FT RT5430RB							
	FT RT6024LB	4943	989	1483	60	24	28.75	42
	FT RT6024RB							
	FT RT6030LB	5055	1011	1517	60	30	28.75	42
	FT RT6030RB							
	FT RT6036LB	5167	1033	1550	60	36	28.75	42
	FT RT6036RB							
	FT RT6624LB	5278	1056	1584	66	24	28.75	48
	FT RT6624RB							
	FT RT6630LB	5390	1078	1617	66	30	28.75	48
	FT RT6630RB							
	FT RT6636LB	5502	1100	1651	66	36	28.75	48
	FT RT6636RB							
	FT RT7224LB	5614	1123	1684	72	24	28.75	54
	FT RT7224RB							
	FT RT7230LB	5725	1145	1718	72	30	28.75	54
	FT RT7230RB							
	FT RT7236LB	5837	1167	1751	72	36	28.75	54
	FT RT7236RB							
	FT RT7824LB	5949	1190	1785	78	24	28.75	60
	FT RT7824RB							
	FT RT7830LB	6060	1212	1818	78	30	28.75	60
	FT RT7830RB							
	FT RT7836LB	6172	1234	1852	78	36	28.75	60
	FT RT7836RB							

Notes

FINISHES

For a complete list of finishes please go to www.deccacontract.com

CODE DESCRIPTION

- B** box / box pedestal
- L** Left pedestal position
- R** Right pedestal position

Dimensions are in inches and are approximate.

Contact Customer Service if dimensions are critical.

* Indicates model illustrated by line drawing.

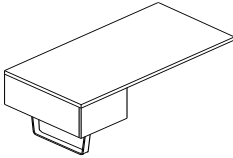
Description		Standard	Premium Metal G1 Upcharge	Premium Metal G2 Upcharge	Width	Depth	Height	Knee Space
Desk Extension Metal Support and 1 file drawer	FT RT4824LF *	4532	906	1359	48	24	28.75	30
	FT RT4824RF							
*	FT RT5424LF	4643	929	1393	54	24	28.75	36
	FT RT5424RF							
	FT RT5430LF	4755	951	1427	54	30	28.75	36
	FT RT5430RF							
	FT RT6024LF	4867	973	1460	60	24	28.75	42
	FT RT6024RF							
	FT RT6030LF	4978	996	1494	60	30	28.75	42
	FT RT6030RF							
	FT RT6036LF	5090	1018	1527	60	36	28.75	42
	FT RT6036RF							
	FT RT6624LF	5202	1040	1561	66	24	28.75	48
	FT RT6624RF							
	FT RT6630LF	5314	1063	1594	66	30	28.75	48
	FT RT6630RF							
	FT RT6636LF	5425	1085	1628	66	36	28.75	48
	FT RT6636RF							
	FT RT7224LF	5537	1107	1661	72	24	28.75	54
	FT RT7224RF							
	FT RT7230LF	5649	1130	1695	72	30	28.75	54
	FT RT7230RF							
	FT RT7236LF	5760	1152	1728	72	36	28.75	54
	FT RT7236RF							
	FT RT7824LF	5872	1174	1762	78	24	28.75	60
	FT RT7824RF							
	FT RT7830LF	5984	1197	1795	78	30	28.75	60
	FT RT7830RF							
	FT RT7836LF	6095	1219	1829	78	36	28.75	60
	FT RT7836RF							

Notes

FINISHES	CODE DESCRIPTION	Dimensions are in inches and are approximate.
For a complete list of finishes please go to www.deccacontract.com	F file pedestal	Contact Customer Service if dimensions are critical.
	L Left pedestal position	
	R Right pedestal position	* Indicates model illustrated by line drawing.

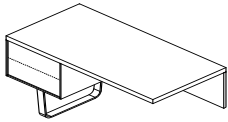
Description		Standard	Premium Metal G1 Upcharge	Premium Metal G2 Upcharge	Width	Depth	Height	Knee Space
Desk Extension Metal Support 2 box drawers and modesty panel	FT RT4824MLB *	4752	950	1426	48	24	28.75	30
	FT RT4824MRB							
*	FT RT5424MLB	4864	973	1459	54	24	28.75	36
	FT RT5424MRB							
	FT RT5430MLB	4975	995	1493	54	30	28.75	36
	FT RT5430MRB							
	FT RT6024MLB	5087	1017	1526	60	24	28.75	42
	FT RT6024MRB							
	FT RT6030MLB	5199	1040	1560	60	30	28.75	42
	FT RT6030MRB							
	FT RT6036MLB	5310	1062	1593	60	36	28.75	42
	FT RT6036MRB							
	FT RT6624MLB	5422	1084	1627	66	24	28.75	48
	FT RT6624MRB							
	FT RT6630MLB	5534	1107	1660	66	30	28.75	48
	FT RT6630MRB							
	FT RT6636MLB	5645	1129	1694	66	36	28.75	48
	FT RT6636MRB							
	FT RT7224MLB	5757	1151	1727	72	24	28.75	54
	FT RT7224MRB							
	FT RT7230MLB	5869	1174	1761	72	30	28.75	54
	FT RT7230MRB							
	FT RT7236MLB	5981	1196	1794	72	36	28.75	54
	FT RT7236MRB							
	FT RT7824MLB	6092	1218	1828	78	24	28.75	60
	FT RT7824MRB							
	FT RT7830MLB	6204	1241	1861	78	30	28.75	60
	FT RT7830MRB							
	FT RT7836MLB	6316	1263	1895	78	36	28.75	60
	FT RT7836MRB							

Notes

FINISHES

For a complete list of finishes please go to www.deccacontract.com

CODE DESCRIPTION

- B** box / box pedestal
- M** modesty panel
- L** Left pedestal position
- R** Right pedestal position

Dimensions are in inches and are approximate.

Contact Customer Service if dimensions are critical.

* Indicates model illustrated by line drawing.

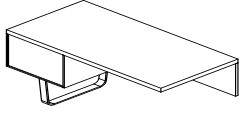
Description		Standard	Premium Metal G1 Upcharge	Premium Metal G2 Upcharge	Width	Depth	Height	Knee Space
Desk Extension Metal Support 1 file drawer and modesty panel	FT RT4824MLF *	4674	935	1402	48	24	28.75	30
	FT RT4824MRF							
*	FT RT5424MLF	4785	957	1436	54	24	28.75	36
	FT RT5424MRF							
	FT RT5430MLF	4897	979	1469	54	30	28.75	36
	FT RT5430MRF							
	FT RT6024MLF	5009	1002	1503	60	24	28.75	42
	FT RT6024MRF							
	FT RT6030MLF	5120	1024	1536	60	30	28.75	42
	FT RT6030MRF							
	FT RT6036MLF	5232	1046	1570	60	36	28.75	42
	FT RT6036MRF							
	FT RT6624MLF	5344	1069	1603	66	24	28.75	48
	FT RT6624MRF							
	FT RT6630MLF	5456	1091	1637	66	30	28.75	48
	FT RT6630MRF							
	FT RT6636MLF	5567	1113	1670	66	36	28.75	48
	FT RT6636MRF							
	FT RT7224MLF	5679	1136	1704	72	24	28.75	54
	FT RT7224MRF							
	FT RT7230MLF	5791	1158	1737	72	30	28.75	54
	FT RT7230MRF							
	FT RT7236MLF	5902	1180	1771	72	36	28.75	54
	FT RT7236MRF							
	FT RT7824MLF	6014	1203	1804	78	24	28.75	60
	FT RT7824MRF							
	FT RT7830MLF	6126	1225	1838	78	30	28.75	60
	FT RT7830MRF							
	FT RT7836MLF	6237	1247	1871	78	36	28.75	60
	FT RT7836MRF							

Notes

FINISHES	CODE DESCRIPTION	Dimensions are in inches and are approximate.
For a complete list of finishes please go to www.deccacontract.com	F file pedestal	Contact Customer Service if dimensions are critical.
	M modesty panel	
	L Left pedestal position	* Indicates model illustrated by line drawing.
	R Right pedestal position	

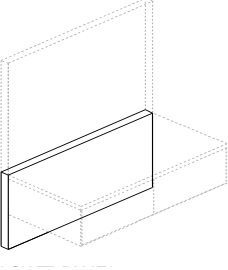
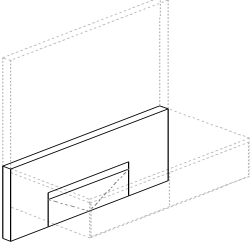
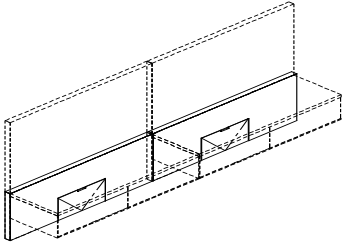
Description	Standard	Width	Depth	Height
Wall mount lower back panel mount on wall cleats 	FT WM18228	894	18	3 28.75
	FT WM30228	983	30	3 28.75
	FT WM36228	1072	36	3 28.75
	FT WM48228	1162	48	3 28.75
	FT WM54228	1251	54	3 28.75
	FT WM60228	1340	60	3 28.75
	FT WM66228	1430	66	3 28.75
	FT WM72228	1519	72	3 28.75
	FT WM78228	1608	78	3 28.75
	FT WM84228	1698	84	3 28.75
	FT WM96228	1787	96	3 28.75
	FT WM102228	1876	102	3 28.75
	FT WM108228	1966	108	3 28.75
	FT WM114228	2055	114	3 28.75
FT WM120228	2145	120	3 28.75	
First access door up-charge 	64			
Second access door up-charge 	718			

Notes

FINISHES

For a complete list of finishes
 please go to www.deccacontract.com

Dimensions are in inches and are approximate.
 Contact Customer Service if dimensions are critical.

* Indicates model illustrated by line drawing.

**PROPER INSTALLATION OF WALL MOUNTED OVERHEAD CABINET IS THE SOLE RESPONSIBILITY OF THE CUSTOMER
 AND IS CRUCIAL TO PREVENT PERSONAL INJURY.**

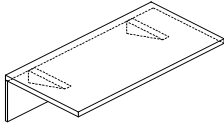
Description		Standard	Width	Depth	Height
Wall Mount Workface with modesty panel mount on wall cleats 	FT B4224M	2055	42	24	28.75
	FT B4230M	2127	42	30	28.75
	FT B4824M	2199	48	24	28.75
	FT B4830M	2271	48	30	28.75
	FT B5424M	2342	54	24	28.75
	FT B5430M	2414	54	30	28.75
	FT B6024M	2486	60	24	28.75
	FT B6030M	2558	60	30	28.75

Notes

FINISHES

For a complete list of finishes
 please go to www.deccacontract.com

CODE DESCRIPTION

M modesty panel

Dimensions are in inches and are approximate.

Contact Customer Service if dimensions are critical.

* Indicates model illustrated by line drawing.

**PROPER INSTALLATION OF WALL MOUNTED OVERHEAD CABINET IS THE SOLE RESPONSIBILITY OF THE CUSTOMER
 AND IS CRUCIAL TO PREVENT PERSONAL INJURY.**

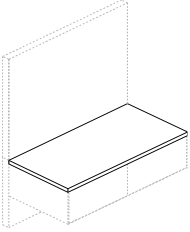
Description	Standard	Width	Depth	Height	
Top Surface 	FT BT1824	766	18	24	1.5
	FT BT1830	807	18	30	1.5
	FT BT3024	849	30	24	1.5
	FT BT3030	890	30	30	1.5
	FT BT3624	932	36	24	1.5
	FT BT3630	973	36	30	1.5
	FT BT4824	1015	48	24	1.5
	FT BT4830	1056	48	30	1.5
	FT BT5424	1098	54	24	1.5
	FT BT5430	1139	54	30	1.5
	FT BT6024	1181	60	24	1.5
	FT BT6030	1222	60	30	1.5
	FT BT6624	1264	66	24	1.5
	FT BT6630	1305	66	30	1.5
	FT BT7224	1347	72	24	1.5
	FT BT7230	1388	72	30	1.5
	FT BT7824	1430	78	24	1.5
	FT BT7830	1471	78	30	1.5
	FT BT8424	1513	84	24	1.5
	FT BT8430	1554	84	30	1.5
	FT BT9024	1596	90	24	1.5
	FT BT9030	1637	90	30	1.5
	FT BT9624	1679	96	24	1.5
	FT BT9630	1720	96	30	1.5
	FT BT10224	3383	102	24	1.5
	FT BT10230	3456	102	30	1.5
	FT BT10824	3530	108	24	1.5
	FT BT10830	3603	108	30	1.5
	FT BT11424	3676	114	24	1.5
	FT BT11430	3750	114	30	1.5
FT BT12024	3823	120	24	1.5	
FT BT12030	3897	120	30	1.5	
Optional add pencil stopper with cable management	FT PS	284	57	85	

Notes

FINISHES

For a complete list of finishes please go to www.deccacontract.com

Dimensions are in inches and are approximate.

Contact Customer Service if dimensions are critical.

* Indicates model illustrated by line drawing.

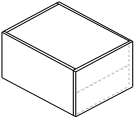
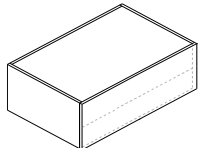
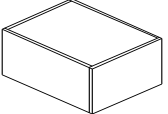
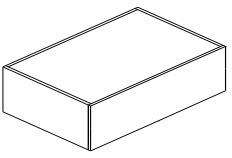
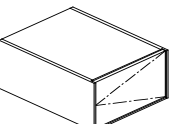
Description		Standard	Width	Depth	Height
Panel Hung Pedestal 2 box drawers *  ** 	FT WP1824B*	3364	18	24	13.35
	FT WP3024B**	3861	30	24	13.35
	FT WP3624B	4359	36	24	13.35
Panel Hung Pedestal 1 file drawer *  ** 	FT WP1824F*	3292	18	24	13.35
	FT WP3024F**	3790	30	24	13.35
	FT WP3624F	4288	36	24	13.35
Panel Hung Pedestal single door cabinet * 	FT WP1824LBC* FT WP1824RBC	2161	18	24	13.35

Notes

FINISHES

For a complete list of finishes please go to www.deccacontract.com

CODE DESCRIPTION

- B** box / box pedestal
- F** file pedestal
- S** open shelf

Dimensions are in inches and are approximate.

Contact Customer Service if dimensions are critical.

* Indicates model illustrated by line drawing.

All panel hung pedestal to be mounted on wall panels that are mounted to partition.

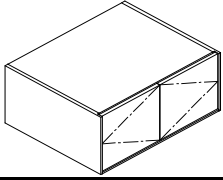
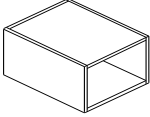
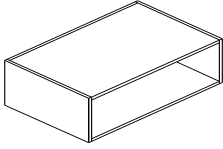
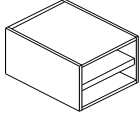
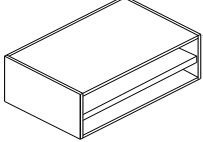
Description		Standard	Width	Depth	Height
Panel Hung Pedestal double door cabinet 	FT WP3024BC	2534	30	24	13.35
	FT WP3624BC	2668	36	24	13.35
Panel Hung Pedestal open shelf *  ** 	FT WP1824S*	2295	18	24	13.35
	FT WP3024S**	2406	30	24	13.35
	FT WP3624S	2518	36	24	13.35
Panel Hung Pedestal open shelf with 1 adjustable shelf *  ** 	FT WP1824OS*	2374	18	24	13.35
	FT WP3024OS**	2486	30	24	13.35
	FT WP3624OS	2598	36	24	13.35

Notes

FINISHES

For a complete list of finishes please go to www.deccacontract.com

CODE DESCRIPTION

- BC** bookcase
- S** open shelf
- OS** 1 adjustable shelf

Dimensions are in inches and are approximate.

Contact Customer Service if dimensions are critical.

* Indicates model illustrated by line drawing.

All panel hung pedestal to be mounted on wall panels that are mounted to partition.

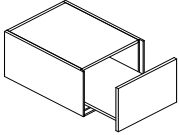
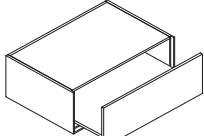
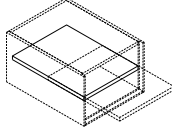
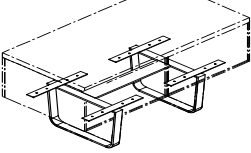
Description		Standard	Width	Depth	Height
Panel Hung Pedestal Printer Drawer	FT WP1824P*	3292	18	24	13.35
* 	FT WP3024P	3790	30	24	13.35
** 	FT WP3624P**	4288	36	24	13.35
Slide out shelf Option Upcharge	FT ST	718			
					
Freestanding Metal Support per piece	FT LEG	1803 361 541			
					

Notes

FINISHES

For a complete list of finishes please go to www.deccacontract.com

CODE DESCRIPTION

P printer drawer
ST slide out shelf

Dimensions are in inches and are approximate.

Contact Customer Service if dimensions are critical.

* Indicates model illustrated by line drawing.

All panel hung pedestal to be mounted on wall panels that are mounted to partition.

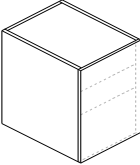
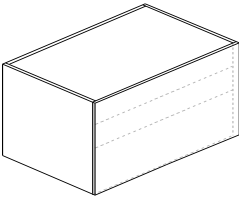
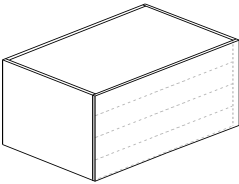
Description	Standard	Width	Depth	Height	
Modular Pedestal	FT MP1824B*	3638	18	24	27.25
box / box / file	FT MP1830B	3893	18	30	27.25
* 	FT MP3024B**	4149	30	24	27.25
	FT MP3030B	4404	30	30	27.25
** 	FT MP3624B	4659	36	24	27.25
	FT MP3630B	4915	36	30	27.25
	FT MP1824P	3710	18	24	27.25
Modular Pedestal	FT MP1830P	3965	18	30	27.25
four pile drawers	FT MP3024P**	4220	30	24	27.25
** 	FT MP3030P	4476	30	30	27.25
	FT MP3624P	4731	36	24	27.25
	FT MP3630P	4986	36	30	27.25

Notes

FINISHES

For a complete list of finishes please go to www.deccacontract.com

CODE DESCRIPTION

B box/box/file pedestal
P 4 pile drawers

Dimensions are in inches and are approximate.

Contact Customer Service if dimensions are critical.

* Indicates model illustrated by line drawing.

All modular pedestals are sit on floor

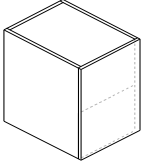
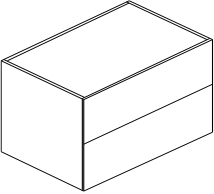
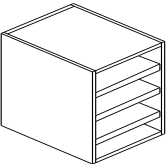
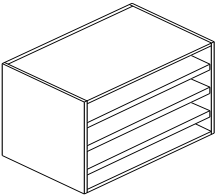
Description	Standard	Width	Depth	Height	
Modular Pedestal	FT MP1824F*	3566	18	24	27.25
file / file	FT MP1830F	3822	18	30	27.25
	FT MP3024F**	4077	30	24	27.25
*	FT MP3030F	4332	30	30	27.25
	FT MP3624F	4587	36	24	27.25
	FT MP3630F	4843	36	30	27.25
**					
					
Modular Pedestal	FT MP1824OS*	2794	18	24	27.25
open shelf unit	FT MP1830OS	2898	18	30	27.25
with 3 adjustable shelf	FT MP3024OS**	3019	30	24	27.25
	FT MP3030OS	3140	30	30	27.25
*	FT MP3624OS	3262	36	24	27.25
	FT MP3630OS	3383	36	30	27.25
**					
					

Notes

FINISHES

For a complete list of finishes please go to www.deccacontract.com

CODE DESCRIPTION

F file / file pedestal
OS open shelf ped

Dimensions are in inches and are approximate.

Contact Customer Service if dimensions are critical.

* Indicates model illustrated by line drawing.

All modular pedestals are sit on floor

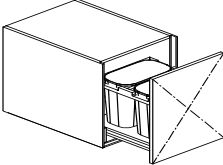
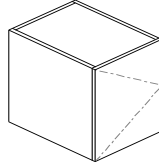
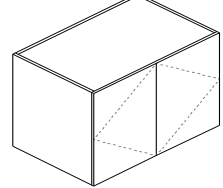
Description		Standard	Width	Depth	Height
Modular Pedestal with trash drawer	FT MP1824T	3638	18	24	27.25
	FT MP1830T	3893	18	30	27.25
					
Modular Pedestal single door unit with 1 adjustable shelf	FT MP1824LBC	2261	18	24	27.25
	FT MP1824RBC*				
	FT MP1830LBC	2365	18	30	27.25
	FT MP1830RBC				
* 					
Modular Pedestal double door unit with 1 adjustable shelf	FT MP3024BC	2582	30	24	27.25
	FT MP3030BC	2735	30	30	27.25
	FT MP3624BC	2888	36	24	27.25
	FT MP3630BC	3041	36	30	27.25
					

Notes

FINISHES

For a complete list of finishes
please go to www.deccacontract.com

CODE DESCRIPTION

- T** trash drawer
- BC** bookcase
- L** left hinge
- R** right hinge

Dimensions are in inches and are approximate.

Contact Customer Service if dimensions are critical.

* Indicates model illustrated by line drawing.

All modular pedestals are sit on floor

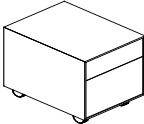
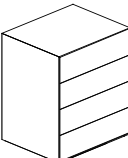
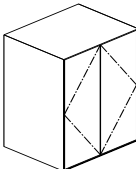
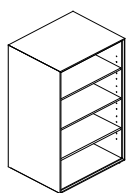
Description		Standard	Width	Depth	Height
Mobile Pedestal box / file	FT M1824BF	3209	18	24	25.5
	FT M1830BF	3464	18	30	25.5
					
Freestanding Storage 4 drawers lateral file unit	FT LT302454	7251	30	24	54
	FT LT362454	7396	36	24	54
					
Freestanding Storage double door behind with 3 adjustable shelves	FT BC302454	4647	30	24	54
	FT BC362454	4860	36	24	54
					
Freestanding Storage open shelf bookcase with 3 adjustable shelves	FT OS301554	3471	30	15	54
	FT OS361554	3617	36	15	54
					

Notes

FINISHES

For a complete list of finishes please go to www.deccacontract.com

CODE DESCRIPTION

BF box / file pedestal

Dimensions are in inches and are approximate.

Contact Customer Service if dimensions are critical.

* Indicates model illustrated by line drawing.

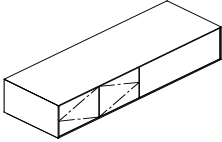
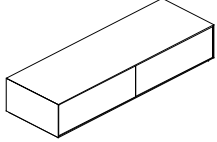
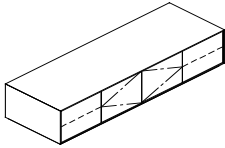
Description		Standard	Width	Depth	Height
Freestanding Low Credenza bookcase & lateral file * 	FT CR7224LBCRLT*	6869	72	24	15
	FT CR7224LLTRBC				
	FT CR7230LBCRLT	7022	72	30	15
	FT CR7230LLTRBC				
	FT CR7824LBCRLT	7176	78	24	15
	FT CR7824LLTRBC				
	FT CR7830LBCRLT	7329	78	30	15
	FT CR7830LLTRBC				
Freestanding Low Credenza two lateral file drawers 	FT CR7224LTLT	7803	72	24	15
	FT CR7230LTLT	7956	72	30	15
	FT CR7824LTLT	8109	78	24	15
	FT CR7830LTLT	8262	78	30	15
Freestanding Low Credenza 	FT CR7224BBCB	8170	72	24	15
	FT CR7230BBCB	8323	72	30	15
	FT CR7824BBCB	8476	78	24	15
	FT CR7830BBCB	8629	78	30	15

Notes

FINISHES

For a complete list of finishes please go to www.deccacontract.com

CODE DESCRIPTION

- LT lateral file drawer
- BC bookcase
- B box / file pedestal

Dimensions are in inches and are approximate.

Contact Customer Service if dimensions are critical.

* Indicates model illustrated by line drawing.

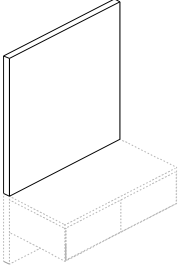
Description	Standard	Width	Depth	Height	
Wall mount upper back panel mounts on wall cleats 	FT WM30216	396	30	3	16
	FT WM30231	437	30	3	31
	FT WM30243	479	30	3	43
	FT WM30258	520	30	3	58
	FT WM36216	562	36	3	16
	FT WM36231	603	36	3	31
	FT WM36243	645	36	3	43
	FT WM36258	686	36	3	58
	FT WM48216	728	48	3	16
	FT WM48231	769	48	3	31
	FT WM48243	811	48	3	43
	FT WM48258	852	48	3	58
	FT WM54216	894	54	3	16
	FT WM54231	935	54	3	31
	FT WM54243	977	54	3	43
	FT WM54258	1018	54	3	58
	FT WM60216	1060	60	3	16
	FT WM60231	1101	60	3	31
	FT WM60243	1142	60	3	43
	FT WM60258	1184	60	3	58
	FT WM66216	1225	66	3	16
	FT WM66231	1267	66	3	31
	FT WM66243	1308	66	3	43
	FT WM66258	1350	66	3	58
	FT WM72216	1391	72	3	16
FT WM72231	1433	72	3	31	
FT WM72243	1474	72	3	43	
FT WM72258	1516	72	3	58	

Notes

FINISHES

For a complete list of finishes
please go to www.deccacontract.com

Dimensions are in inches and are approximate.
Contact Customer Service if dimensions are critical.

* Indicates model illustrated by line drawing.

**PROPER INSTALLATION OF WALL MOUNTED OVERHEAD CABINET IS THE SOLE RESPONSIBILITY OF THE CUSTOMER
AND IS CRUCIAL TO PREVENT PERSONAL INJURY.**

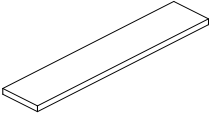
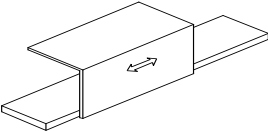
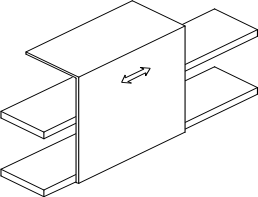
Description		Standard	Width	Depth	Height
Overhead shelving 	FT WS1812	766	18	12	2
	FT WS3012	839	30	12	2
	FT WS3612	913	36	12	2
	FT WS4212	913	42	12	2
	FT WS4812	986	48	12	2
	FT WS5412	1060	54	12	2
	FT WS6012	1133	60	12	2
	FT WS6612	1206	66	12	2
	FT WS7212	1280	72	12	2
	FT WS7812	1353	78	12	2
	FT WS8412	1427	84	12	2
	FT WS9612	1500	96	12	2
	FT WS10212	1573	102	12	2
	FT WS10812	1647	108	12	2
	FT WS11412	1720	114	12	2
FT WS12012	1794	120	12	2	
One shelf overhead with sliding door 	FT W361316	3155	36	13	16
	FT W481316	3228	48	13	16
	FT W541316	3301	54	13	16
	FT W601316	3375	60	13	16
	FT W661316	3448	66	13	16
	FT W721316	3522	72	13	16
Two shelves overhead with sliding door 	FT W361331	3823	36	13	31
	FT W481331	3906	48	13	31
	FT W541331	3989	54	13	31
	FT W601331	4072	60	13	31
	FT W661331	4155	66	13	31
	FT W721331	4238	72	13	31

Notes

FINISHES

For a complete list of finishes please go to www.deccacontract.com

Dimensions are in inches and are approximate.

Contact Customer Service if dimensions are critical.

* Indicates model illustrated by line drawing.

All overheads to be mounted on wall panels that are mounted to partition.

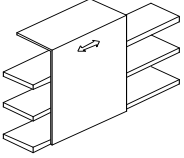
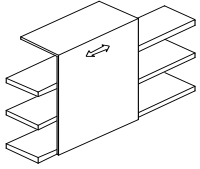
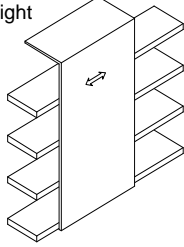
Description		Standard	Width	Depth	Height
Three shelves overhead with sliding door 	FT W361342	4449	36	13	42
	FT W481342	4564	48	13	42
	FT W541342	4678	54	13	42
	FT W601342	4793	60	13	42
	FT W661342	4908	66	13	42
	FT W721342	5023	72	13	42
Two shelves overhead with sliding door full height 	FT W361354	4495	36	13	54
	FT W481354	4610	48	13	54
	FT W541354	4725	54	13	54
	FT W601354	4840	60	13	54
	FT W661354	4954	66	13	54
	FT W721354	5069	72	13	54
Three shelves overhead with sliding door full height 	FT W361357	5122	36	13	57
	FT W481357	5253	48	13	57
	FT W541357	5384	54	13	57
	FT W601357	5515	60	13	57
	FT W661357	5645	66	13	57
	FT W721357	5776	72	13	57

Notes

FINISHES

For a complete list of finishes please go to www.deccacontract.com

Dimensions are in inches and are approximate.

Contact Customer Service if dimensions are critical.

* Indicates model illustrated by line drawing.

All overheads to be mounted on wall panels that are mounted to partition.

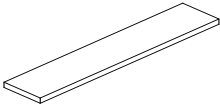
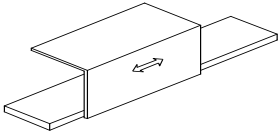
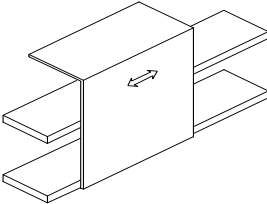
Description		Standard	Width	Depth	Height
Overhead shelving with LED lighting 	FT WS1812D	889	18	12	2
	FT WS3012D	962	30	12	2
	FT WS3612D	1036	36	12	2
	FT WS4212D	1036	42	12	2
	FT WS4812D	1109	48	12	2
	FT WS5412D	1182	54	12	2
	FT WS6012D	1256	60	12	2
	FT WS6612D	1329	66	12	2
	FT WS7212D	1403	72	12	2
	FT WS7812D	1476	78	12	2
	FT WS8412D	1549	84	12	2
	FT WS9612D	1623	96	12	2
	FT WS10212D	1696	102	12	2
	FT WS10812D	1770	108	12	2
	FT WS11412D	1843	114	12	2
FT WS12012D	1916	120	12	2	
One shelf overhead with sliding door and LED lighting 	FT W361316D	3533	36	13	16
	FT W481316D	3686	48	13	16
	FT W541316D	3839	54	13	16
	FT W601316D	3992	60	13	16
	FT W661316D	4146	66	13	16
	FT W721316D	4299	72	13	16
Double High Overhead shelving with sliding door and LED lighting 	FT W361331D	4201	36	13	31
	FT W481331D	4355	48	13	31
	FT W541331D	4508	54	13	31
	FT W601331D	4661	60	13	31
	FT W661331D	4814	66	13	31
	FT W721331D	4967	72	13	31

Notes

FINISHES

For a complete list of finishes please go to www.deccacontract.com

CODE DESCRIPTION

D LED

Dimensions are in inches and are approximate.

Contact Customer Service if dimensions are critical.

* Indicates model illustrated by line drawing.

All overheads to be mounted on wall panels that are mounted to partition.

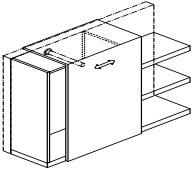
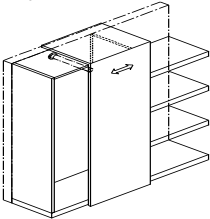
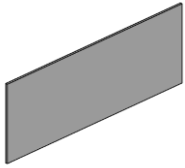
Description		Standard			
			Width	Depth	Height
Overhead WTD Unit sliding door one side with coat rod one side with 2 shelves no back panel * 	FT W481342LC*	5215	48	13	42
	FT W481342RC				
	FT W541342LC	5329	54	13	42
	FT W541342RC				
	FT W601342LC	5444	60	13	42
	FT W601342RC				
	FT W661342LC	5559	66	13	42
	FT W661342RC				
	FT W721342LC	5674	72	13	42
	FT W721342RC				
Overhead WTD Unit sliding door one side with coat rod one side with 3 shelves no back panel * 	FT W481357LC*	5489	48	13	57
	FT W481357RC				
	FT W541357LC	5604	54	13	57
	FT W541357RC				
	FT W601357LC	5719	60	13	57
	FT W601357RC				
	FT W661357LC	5834	66	13	57
	FT W661357RC				
	FT W721357LC	5949	72	13	57
	FT W721357RC				
Optional add LED light on overhead interior shelf	FT LED	587			
Tack panel 		COM	G1	G2	
	30" WTD	118	408	563	
	36" WTD	118	575	786	
	48" WTD	153	670	917	
	54" WTD	159	738	1012	
	60" WTD	164	738	1012	
	66" WTD	199	819	1121	
	72" WTD	211	902	1237	

FINISHES

For a complete list of finishes please go to www.deccacontract.com

CODE DESCRIPTION

- C coat rod
- L left position
- R right position

Dimensions are in inches and are approximate.

Contact Customer Service if dimensions are critical.

* Indicates model illustrated by line drawing.

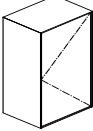
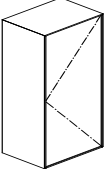
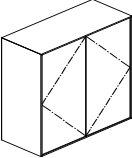
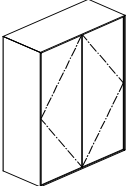
Description	Standard	Width	Depth	Height
<p>Worksurface Cabinet FT H181342L* single door FT H181342R behind with 2 shelves *</p> 	2620	18	13	42
<p>Worksurface Cabinet FT H181357L* single door FT H181357R behind with 3 shelves *</p> 	2928	18	13	57
<p>Worksurface Cabinet FT H301342 double door FT H361342 behind with 2 shelves</p> 	3068	30	13	42
<p>Worksurface Cabinet FT H301357 double door FT H361357 behind with 3 shelves</p> 	3375	30	13	57

Notes

FINISHES

For a complete list of finishes please go to www.deccacontract.com

CODE DESCRIPTION

- L left hinge
- R right hinge

Dimensions are in inches and are approximate.

Contact Customer Service if dimensions are critical.

* Indicates model illustrated by line drawing.

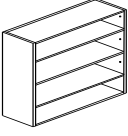
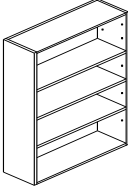
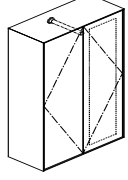
Description		Standard	Width	Depth	Height
Worksurface Cabinet with 3 ajustable shelf 	FT H181342S	2585	18	13	42
	FT H301342S	2776	30	13	42
	FT H361342S	2968	36	13	42
Worksurface Cabinet with 4 ajustable shelf 	FT H181357S	2681	18	13	57
	FT H301357S	2872	30	13	57
	FT H361357S	3064	36	13	57
Worksurface Cabinet double door with mirror & coat rod 	FT H301342C	2957	30	13	42
	FT H361342C	3110	36	13	42
	FT H301357C	3263	30	13	57
	FT H361357C	3416	36	13	57

Notes

FINISHES	CODE DESCRIPTION	Dimensions are in inches and are approximate.
For a complete list of finishes please go to www.deccacontract.com	L left hinge R right hinge	Contact Customer Service if dimensions are critical.

* Indicates model illustrated by line drawing.

All worksurface cabinet to be mounted on wall panels that are mounted to partition.

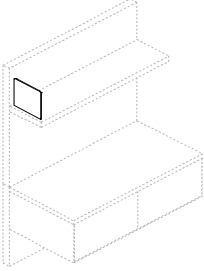
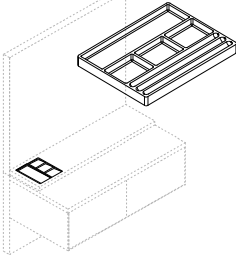
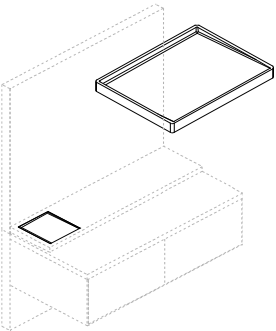
Description	Standard	Premium Metal G1 Upcharge	Premium Metal G2 Upcharge	Width	Depth	Height
<p>Metal Shelf Bookend FT BKE</p> 	432	86	130	10	0.25	10
<p>Desk top accessories FT CAS129 Utility</p> <p>White solid surface</p>  <p>* Black solid surface availbale.</p>	2421			12.65	9.60	2
<p>Desk top accessories FT CAT129 Letter</p> <p>White solid surface</p>  <p>* Black solid surface availbale.</p>	2192			12.65	9.60	2
<p>FT CAT150 Legal</p> <p>2352</p> <p>15.7 9.60 2</p>						

Notes

FINISHES

For a complete list of finishes please go to www.deccacontract.com

Dimensions are in inches and are approximate. Contact Customer Service if dimensions are critical.

* Indicates model illustrated by line drawing.