

GENERAL PRODUCT SPECIFICATIONS

VENEERS

All exposed surfaces are offered in hand selected veneers. All veneer surfaces are book-matched resulting in superior wood grain aesthetics.

WORK SURFACES

Tops are 1.5" thick. Desks have profiled edges front and back and flush side panels. All worksurface height tops also have chemically impregnated polycell backer for additional worksurface durability.

ENEER FINISH

A multi-step modified polyurethane finish is applied to all finished cases.

STANDARD FINISHES:

- #100 CLEAR MAPLE
- #104 CHAMPAGNE CHERRY
- #105 LIGHT CHERRY
- #107 AMERICAN CHERRY
- #119 BEECH
- #121 COFFEE
- #125 FLAT CUT NON-FIG WALNUT
- #126 NATURAL OAK
- #133 SAND OAK
- #134 FOREST OAK
- #136 DARK OAK

PREMIUM VENEER:

- Available optional finishes on work surface
- Upcharge 20%
- #115 FIGURED ANIGRE
- #116 BIRDEYES MAPLE
- #117 EBONY
- #118 MAHOGANY
- #124 PRIMA VERA-FIGURED
- #129 SMOKE GRAY ASH
- #130 SMOKE EBONY
- #131 INK EBONY
- #132 WHEAT SYCAMORE

ENGINEERING VENEER FINISHES:

- #504 EV QUARTER CUT LIGHT GRAY OAK
- #505 EV BLACK APRICOT
- #507 EV FLAT CUT OAK
- #508 EV WHITE OAK
- #509 EV TEAK
- #510 EV CLEAR QUARTER CUT OAK
- #511 EV WHITE RATTAN

For exotic veneer on entire unit, please contact Customer Service.

EXOTIC VENEERS:

- AVODIRE
- BUBINGA
- EUCALYPTUS
- HIGHLY FIGURED ANIGRE
- POMMELE SAPELE
- WENGE
- Other Species Available*

GENERAL PRODUCT SPECIFICATIONS

For lacquer finish apply on drawer face / door or surround, please contact Customer Service.

LACQUER FINISHES:

- 005 PURE WHITE
- 006 SOFT WHITE
- 010 WARM WHITE
- 009 PEARL WHITE
- 008 WARM DARK GRAY
- 011 GLOSSY PURE WHITE

METAL FINISH

STANDARD FINISHES:

- #304 SILVER POWDER COATED
- #305 BLACK POWDER COATED
- #306 DARK BRONZE POWDER COATED
- #310 SOFT WHITE
- #311 WARM DARK GRAY

PREMIUM FINISHES:

- #301 POLISHED STAINLESS STEEL
- #302 SATIN STAINLESS STEEL
- #308 SATIN DARK BRONZE
- #309 SATIN BRONZE

GLASS FINISHES:

- #401 WHITE BACK PAINTED GLASS
- #402 BLACK BACK PAINTED GLASS
- #403 FROSTED MIRROR GLASS
- #406 FROSTED GLASS
- #407 BLACK MIRROR GLASS
- #408 CLEAR LOW IRON GLASS
- #409 BRONZE FROSTED MIRROR GLASS
- #410 GRAY FROSTED MIRROR GLASS
- #411 BLACK FROSTED MIRROR GLASS
- #412 ARCHITECTUAL WHITE BACK PAINTED GLASS

SOLID SURFACE

- #404 SSF WHITE
- #405 SSF BLACK

VENEER LAYUP OPTIONS

In addition to our expansive portfolio of standard and exotic veneers, DECCA also offers finely crafted veneer patterns. These handcrafted patterns add a level of aesthetic detail that will give a unique signature to any project. Inspired designs are enhanced by the use of DECCA veneer artwork.

OPTIONS

Available upon request at an upcharge. Contact DECCA Contract Customer Service at info@deccacontract.com

STANDARD

BOOK MATCH



SLIP MATCH

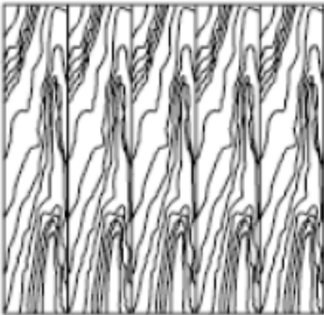

DIAMOND

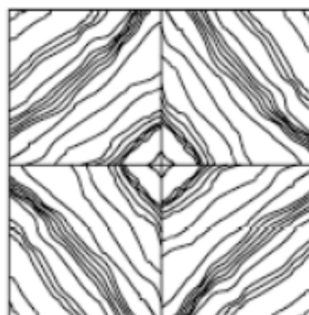

REVERSE DIAMOND

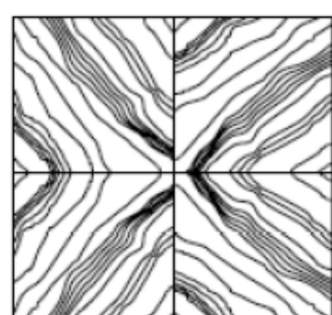

BOX

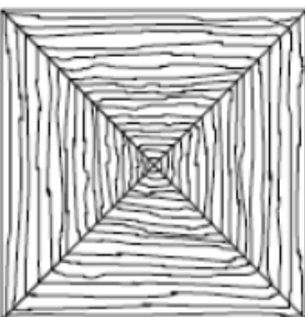

REVERSE BOX

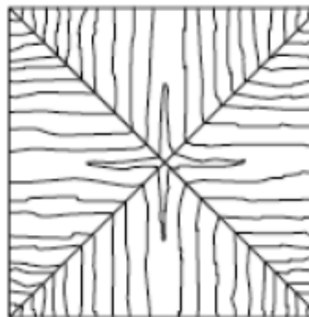

SUNBUSRT

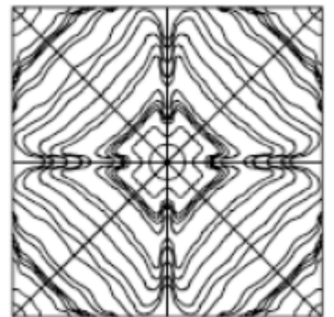

CHECKERBOARD

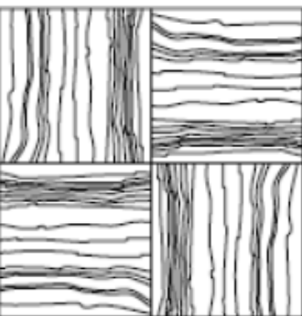

HERRINGBONE

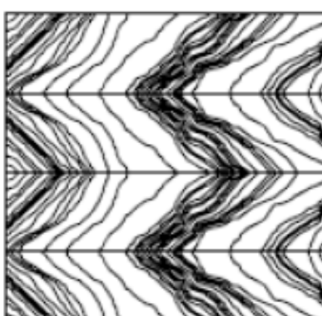

GROMMETS

All cases may be specified with one grommet in a standard position at no charge. A \$64 list upcharge will apply to all grommets requested in non-standard positions. The grommet position must be indicated for each case on the order.

Standard:

Round shape solid wood;
finish same as work surface.
Diameter 3.25"



Grommet holes are located 4.5" from the back of the unit and 9" from the inside edge of the pedestal.

Please keep in mind the location of grommets when specifying paper managers for use with worksurfaces.

Standard wall access 4"x2" on fixed back panel

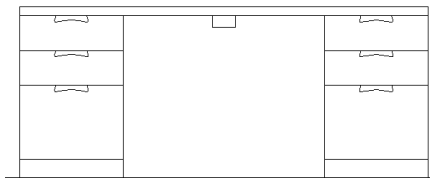

Identifiers A and C1 are to be used if a grommet is to be located over a desk pedestal. The left or right placement of the pedestal does not change the location identification letter.

Identifiers B and C2 are to be used if a grommet is to be located on a desk worksurface without a pedestal beneath.

Identifier D is for a grommet location in the center of a bridge or return.

Identifier E, G and H is for a grommet location centered in the kneespace.

Identifier F is for a inside corner grommet location.

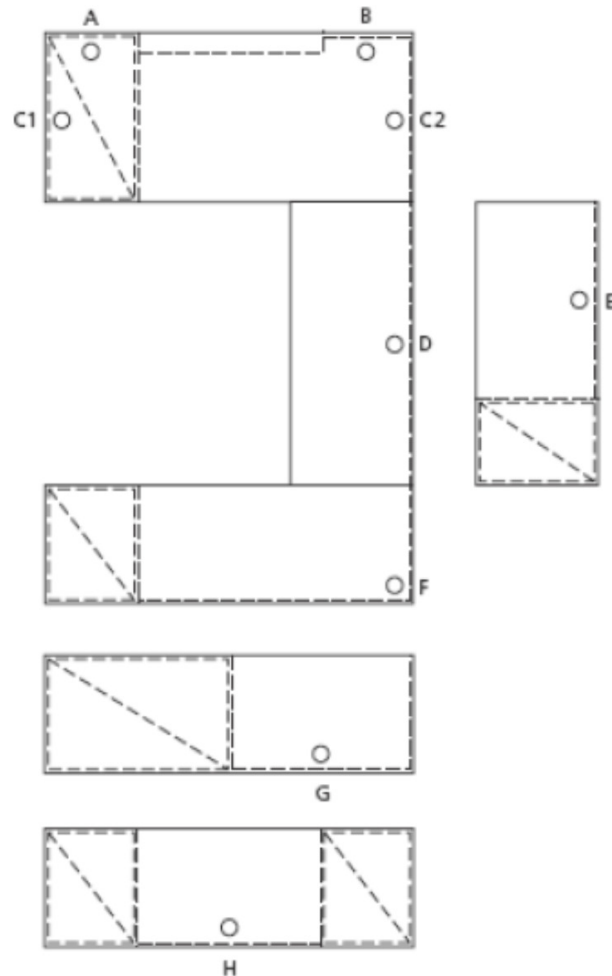

POWER AND TELECOMMUNICATIONS

Decca Contract offers an engineered enclosure for the connection of portable technologies to building infrastructure through the Decca Power Point.

The Decca Power Point combines electrical and ata outlets into one enclosure. The power and data elements are separated by a removable barrier within the enclosure.

The Decca Power Point is both UL and CSA listed with a 8" black power cord and a 15 amp, 125 volt plug. Duplex power receptacles are rated for 15 amps.

The Decca Power Point can be specified hard wire ready to enable a connection to building infrastructure on site by a licensed electrician and following all local electrical code requirements.

- A. Accepts various modular screw-down face plates.
- B. Supports all structured data wiring systems.
- C. Convenient under surface 90 degree trough design.
- D. Durable powder coated 16 guage steel construction.
- E. Electrical and voice/data in a single enclosure.

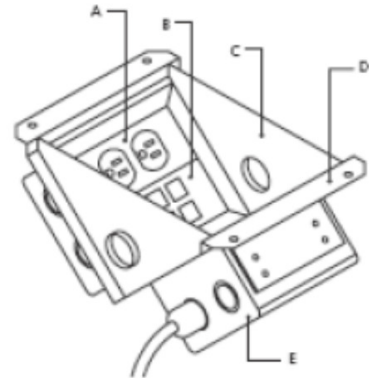

LOCKS

Lock plugs are standard and are located on the side panel of pedestal. Locks are optional on door fronts and must be specified at time of order. Suites can be keyed alike at no upcharge, please specify on your purchase order. Lock finish: Black is standard, Silver is available if specified on the order.

DRAWERS

All drawers utilize high precision ball bearing slides to ensure smooth, quiet operation and use three-stage, full extension slides for maximum load capacity.

Drawer interiors are veneered with the same veneer and finish as the work surface.

DESK PEDESTAL FILE DRAWERS

Filing Capacity: 24" of letter filing front to back, or 12" legal filing side to side.

GLIDES

Adjustable glides allow for a range of 1" vertical adjustment that can be accessed from the top with a screwdriver.

HINGES

Hinges on doors are standard with 90 degree opening and are self closing. Hinges on glass door are standard with 90 degree opening. Special degree opening hinges are by request only. All hinges are fully adjustable.

WALL MOUNT CABINETS

Wall mounted products are supplied with an adequate mounting device, but not with hardware to attach this device to the support wall. It is the responsibility of the dealer/installer to ensure that the wall structure is adequate to support the product and that the attachment device is properly secured to the wall structure. Decca is not responsible for damages caused by improper installation of wall mounted products. Decca is not responsible for damage to our furniture products, building components or property caused by improper installation of wall mounted products. Damage will not be considered a warranty issue.

Proper installation of Decca Contract products is the responsibility of the dealer. Improperly installed products can result in permanent damage to case components. Damage due to improperly installed furniture is not covered under the product warranty.

WALL MOUNTING

Decca Contract Furniture will not accept responsibility for the attachment of any of our products to the client wall(s). The wall specification and construction is the responsibility of the customer/architect. Improper attachment of Decca products to wall(s) could lead to property damage and injuries.

The customer/architect is responsible for determining and verifying that the building structural components (studs, blocks, masonry, etc.), upon which the Decca products will be mounted, are suitable for supporting the weight.

The manner in which the Decca products are mounted to the wall(s) is the responsibility of the customer/architect. Additionally, it is the customer/architect responsibility to select the appropriate fasteners and method of attachment.

A structural engineer, or architect, should be consulted prior to work beginning. This information is only a guide and must not be relied upon for the installation of components.

MAHARAM TACKBOARD FABRIC**GRADE 1**

Crisp Backed	901420
Glint	901380
Parallel	901180

GRADE 2

Field	901170
-------	--------

To order samples, or to check stock, please visit www.maharam.com
or call (800) 645-3943